

HF / RF  
Electrosurgical Units  
**SMT BM M** and **SMT BM M P**  
150 200 250 300 350 400



CE 1014

**Operating Instructions**



## CONTENT:

1. INTRODUCTION .....	2
1.1 The Principles of the Safe Use.....	2
2. ELECTROSURGICAL SYSTEM SMT BM M .....	4
2.1 Control Unit .....	4
2.2 Surgical Tool - Applicator CUT-COAG .....	5
2.3 Active Electrodes - Operating Instruments .....	6
2.4 Neutral (Patient) Electrode - the Contact Part .....	6
2.5 Foot-Operated Switch .....	7
3. TECHNICAL DESCRIPTION AND BASIC SPECIFICATIONS .....	7
3.1 Used symbols: .....	8
3.2 Operating Instrument Holder - Applicator.....	9
3.3 Neutral Electrode.....	9
3.4 Pneumatic Foot Switch (single or single + double) .....	9
3.5 Electrodes and Accessory .....	9
4. INSTALLATION .....	9
5. MAINTENANCE .....	12
5.1 Programs settings (only with the programmable Units "P") .....	12
5.2 Sterilization .....	13
5.3 Cleaning .....	14
5.4 Troubleshooting and Reparations .....	14
5.5 Preventative Inspections, Revisions.....	14
5.6 Guarantee .....	15
5.7 Instructions for the Realization of Guarantee Repair .....	15
6. THE FULFILMENT OF LEGISLATIVE REQUIREMENTS .....	15
7. ELECTROSURGICAL UNIT AND SUPPLIED ACCESSORY .....	16
7.1 The basic accessory:.....	16
7.2 The additional accessory: .....	16
8. APPENDIX .....	17
9. MAXIMAL POWERS OF THE BM M UNITS .....	18

INDEMNITY AGREEMENT  
FINAL USER REGISTRATION CARD  
DECLARATION OF CONFORMITY

## Manufacturer:

### Special Medical Technology, Co. Ltd.

Papírenská 114/5

160 00 Prague 6

Czech Republic, EUROPEAN UNION - EU

Phone: +420 233 320 201, Fax: +420 224 318 011

E-mail: [smt-praha@smt-praha.com](mailto:smt-praha@smt-praha.com), [obchod@smt-praha.com](mailto:obchod@smt-praha.com)

Internet: [www.smt-praha.com](http://www.smt-praha.com)

Device classification class:..... **II b**

Device service life:.....**7 years**

## 1. INTRODUCTION

With regard to parallel running development of the device, some specifications and technical data subject to change without previous notice.

No part of the following document is permitted to be photographed, copied or translated into other languages without previous manufacturer's written agreement.

In case of need for an engineering assistance, please contact the supplier.

This manual must be kept for future possible consultation.

### 1.1 The Principles of the Safe Use

The operation of all high-frequency Electrosurgical instruments breeds certain risks, the minimization of which needs observing particular rules. We have presented the comprehensive list of these rules herein to ensure lucidity, although, many of them are repeatedly mentioned hereafter.

**These instructions were draft out for your safety and for the safety of other participants. Before you start installing and operating this unit, please read them carefully to be sure to get the best possible performance at highest possible safety:**

1. The qualification required for operating an Electrosurgery Unit must be at a University grade in a medical branch.
2. In case of using some other accessory than supplied by manufacturer (input cords, active and neutral electrodes), it's necessary to consult the

manufacturer, so that the incompatibility and thus the dangerous operation may be prevented.

3. The neutral electrode has to be reliably and firmly connected up with the PATIENT's body with its whole contact surface as near as possible to the operation area.
4. The PATIENT must not come into contact with any metallic parts that are earthed or have high earth capacitance (e.g. surgical table, rests, and the like). When this is the case, we recommend using antistatic bed-clothes.
5. It's necessary to prevent any contact skin - skin (e.g. between an arm and a body of a PATIENT) by applying dry gauze.
6. If a high-frequency electrosurgical unit and a monitoring device are used at a PATIENT simultaneously, monitoring electrodes should be placed at the farthest possible distance from surgical electrodes. We don't recommend using needle monitoring electrodes. Anyhow, it's advisable to use monitoring systems with the limitation of high-frequency current.
7. The electrode input cords have to be placed in such a way that any contacts with the PATIENT's body or other electric conductors are prevented.  
The temporarily unused active electrodes have to be kept separately from the PATIENT.
8. At performing such surgical procedures when high-frequency current can flow through the parts of the patient's body with relatively small cross-sections, we recommend to use the bipolar technique to avoid the unintentional coagulation.
9. The output function has to be set at the minimum level for a given elemental operation.
10. The improperly used neutral electrode or its inconvenient or incorrect connection can cause demonstrably decreased output function or the system malfunction. The function of such Electrosurgical Unit isn't optimal even at standard operational conditions.
11. If a surgical operation is performed in the area close to chest or head, the use of combustible anaesthetics or oxidizing gases (e.g. dinitrogen oxide /N<sub>2</sub>O/ and oxygen) must be avoided, unless the vapour drawing off is ensured. The incombustible substances have to be used wherever possible. The combustible substances, used for cleaning, disinfecting, or as a solvent, must evaporate off before the application of the high-frequency surgery. The accumulation of combustible

substances under the PATIENT or in PATIENT's sinuses, e.g. abdomen or vagina, may be dangerous. Before using the Unit, the combustible substances have to be absorbed from these spaces by gauze. Pay close attention to the danger of inflammation of endogenous gases. The potential sparking can occur and cause the inflammation of some substances (e.g. absorbent cotton and gauze saturated with oxygen) even at normal application of the Unit.

12. Patients with pacemakers or other active implantations are endangered by the eventual interference of Electrosurgical Unit with running pacemaker. Such implantations can be damaged as well. In case of any doubt a specialists - anaesthesiologist has to assist at the operation.
13. You must count on the interference, arising from the operation of high-frequency Electrosurgical Unit, which can negatively affect the function of other electronic equipment.
14. During an activated output function, this Unit could be a source of an interference with other devices, placed nearby and sensitive to electromagnetic field. A possible precaution is placing the electrocauter and an interferred device far between.
15. The preventative inspections of the Unit including its accessory must be done regularly. It is important to pay special attention to the condition of insulation of the electrode input cords.
16. Any unprofessional encroaching up on the Unit must be avoided. Have all revisions, reconditions, and inspections carried out by the manufacturer or by the chartered service.
17. To minimize risks and consequences of possible power cut, we recommend using the Unit in operating theatres equipped with stand-by power distribution. At ambulatory applications the Unit should be fed from stand-by power supply (UPS).
18. Have the Electrosurgical system overhauled concerning the safety by the manufacturer or at the chartered service minimum once a year.

## **2. ELECTROSURGICAL SYSTEM SMT BM M**

### **2.1 Control Unit**

The electrosurgery generator is a high-frequency high-powered generator, controlled by inbuilt microprocessor. Its output current can be modulated to be suitable for the incision, coagulation and their various combinations.

The operator can control the output function level in such a way that it fully complies with his needs. The output function is adjustable in the range of many stages (Min. - Max.). The Unit can operate either in MONOPOLAR or in BIPOLAR mode. In each mode, it's possible to select the current for the incision, mixed incision, coagulation or micro-coagulation and/or spray. The micro output is practicable in particular also for high-frequency needle epilation. Moreover, also in each mode, the output function level can be increased or decreased from min. up to max. by the output digital function controller situated on the front panel.

### 2.1.1 Colour-Light Indicators

Green	POWER SUPPLY - the Unit is on
Green	switch position MONOPOLAR - BIPOLAR
Yellow	CUT - current of the output function is selected for the incision
Green	MIXED INCISION (BLEND) - current of the output function is selected for the mixed incision
Blue	COAG - current of the output function is selected for the coagulation
Orange	MICRO (EPI) - current of the output function is selected for the microcoagulation (epilation)
Silver	SPRAY - current of the output function is selected for fulguration
Red	NEUTRAL ELECTRODE (alarm) - the system malfunction in the circuit of neutral electrode, above all

## 2.2 Surgical Tool - Applicator CUT-COAG

The basic Hand or Foot actuated operating Applicator fixates the active electrode selected for a particular electro surgery operation. The most frequent applications are the incision by scalpel, loop electrode LOOP or needle electrode, and coagulation by ball electrode BALL. (All that supplied by manufacturer of this Electrosurgical Unit.) The hand actuating is possible for CUT and COAG outputs in MONO mode. The foot actuating is possible for all ten outputs in both modes.

The miniature applicator is an instrument which is very often used in micro-surgery. It is suitable for the micro-coagulation and epilation. This applicator fixates the needle that functions as an active electrode. It's also possible to use tweezers (forceps) - the bipolar mode. A special possibility offers the using of monopolar tweezers, which are connected to plug contact M - monopolar, and where the second electrode is again the

neutral one. (All that also supplied by the manufacturer of this Electrosurgical Unit.)

### **2.3 Active Electrodes - Operating Instruments**

The active electrodes concentrate high-frequency current and apply it into tissue. According to their shape, they are intended especially for the incision or for the coagulation. The thin wire electrodes, straight or loop, are usually used for the incision. The loop electrodes are used for the tissue excision.

The ball electrodes are used for coagulation. Standardized chucking diameter of electrode shank is 2,4 mm. The electrode tip is partly sterilized by high-frequency energy that destroys also germs accidentally occurring in the operation area. But the electrodes should be repeatedly sterilized - by any conventional methods. Manufacturer recommends sterilization by steam - see Chapter 5.2.

### **2.4 Neutral (Patient) Electrode - the Contact Part**

The neutral electrode closes the circuit. It must be fastened reliably and with its entire contact surface to the patient body as near as possible to the operation area. It is usually a plate made of silicone conductive rubber, or a plastic disposable dispersive conductive plate.

This part of the electro surgery set is very important. The International Safety Directives require the parallel monitoring of the safe fastening of the neutral electrode to the patient body. If the neutral electrode is disconnected, or, if though one wire of the two-core input connection cord is broken and simultaneously the monopolar mode is selected, then two warning red lights (on the left on the front panel) intermittently flicker and the panel sounds with the intermittent acoustic signal. The function is interrupted. This warning is also activated whenever the electric circuit of the neutral electrode is disconnected in the course of a surgical treatment. If a situation like this occurs, such electrode must be overhauled, and, if need be, replaced. The visual checking of all electrodes and their input connection cords is recommended before each operation.

Using neutral electrode is of vital importance for perfect execution of a surgical treatment with the minimum and safest possible current, and also for the due operation of the Unit. (An operation without neutral electrode requires the higher output function. Moreover, unless the neutral electrode is applied, many various effects, e.g. weight of the patient,



conductivity of patient skin, and also the position of an operator, could affect the high-frequency impedance and thus influence the operation of the electrosurgical instrument and that way also the surgical treatment.)

The neutral electrode must be placed in such a way, that it forms the reliable compact contact with a part of the patient's body.

When you use the neutral electrode observing the Principles of the Safe Use (specified in Chapter 1.1.) is obligatory.

Silicone rubber neutral electrodes:

The SMT BM M safety Units use the safety double plates. These plates have to be connected to the patient with the **conductive - black** part! A special - conductive gel is recommended. The flammable gels must not be used!

Dispersive neutral electrodes for one use:

This type of neutral electrode is in the basic equipment of all SMT BM M ES Units (10 pcs).

This type has been produced as a single (solid) and/or double (split). In addition, these types can be ordered for adults, children or infants, both solid (single) or split (double). For these electrodes is not suitable to use any gel. (Because they are already equipped with a conductive, adhesive layer.)

## 2.5 Foot-Operated Switch

The foot-operated switch is the pneumatic one, without any electric cords, therefore highly safe. It controls all operating outputs in both modes MONO and BIPO.

## 3. TECHNICAL DESCRIPTION AND BASIC SPECIFICATIONS

Types:	SMT BM M 150, SMT BM M 200, SMT BM M 250, SMT BM M 300, SMT BM M 350, SMT BM M 400
Supply voltage	230 V / 50 Hz (or 110 V / 60 Hz)
Load inputs	210; 280; 350; 420; 500; 560 VA
No-load input I	3 VA
No-load input II	8 VA
<b>Outputs</b>	<b>150, 200, 250, 300, 350, 400 W / 500 Ohm</b>
Operating frequency	460 kHz
Insulation class	II ☐
Dimensions /mm/	310x290x80

Weight	6 kg
Power supply transformer	Prim. 230 V sec. 1 = 120 V sec. 2 = 16 V CSN EN 60601-1

The operation and storing of the Unit:

Ambient temperature: ..... +10°C up to +40°C

Relative humidity: ..... from 30% to 75%

Atmospheric pressure: ..... from 700 kPa to 1060 kPa

Index of protection against an undesirable water penetration: ..... protection IP 21

Models BM M 350 MAJOR and BM M 400 MAXIM make possible to the operator to work under water (in urology, gynaecology, orthopedy for inst.) in Saline (TURiS, TCRiS, BiTUR) by highly safe **Bipolar way** with high power 260 – 340 W.

The Unit was certified by the procedure conformably to CSN EN 60601-1:1994, CSN EN 60601-2-2:2001, CSN EN 60601-1-2:2003, CSN EN 55011, 93/42 EEC Standards.

### 3.1 Used symbols:

The Unit is type BF with protection against defibrillation discharge, the corresponding symbol on the Unit is  .

The Unit operates with high-frequency energy with nonionizing radiation, the corresponding symbol is  .

The electrode type F, the corresponding symbol  on the rear panel of the Unit.

Foot-operated switch, the corresponding symbol  on the rear panel.

The instruction "ATTENTION, consult enclosed documentation", the corresponding symbol on the rear panel of the Unit is  .

### 3.2 Operating Instrument Holder - Applicator

The essential accessory of the Unit is the basic applicator for monopolar application, with the double hand switch for "CUT" and "COAG". The bipolar or monopolar tweezers and bipolar cable can be bought extra as the optional accessory. See SMT leaflets.

### 3.3 Neutral Electrode

The floating input for an electrode type F, see the corresponding symbol **F** on the rear panel of the Unit.

### 3.4 Pneumatic Foot Switch (single or single + double)

Data:

Diameter .....	109 mm
Length of the inlet tube .....	cca 3 m
Weight .....	0.25 kg

Foot-operated switch, see the corresponding symbol  on the rear panel.

### 3.5 Electrodes and Accessory

The manufacturer supplies the electrodes in the assortment specified in Chapter 7. If you need to upgrade the assortment and purchase other accessory, please follow instructions in Article 2, Chapter 1.1.

## 4. INSTALLATION

The technical limits of the Unit are defined by the following technique of operation:

INTERRUPTED OPERATION - operation 120 s, interruption 30 s, the new Units BM M allow uninterrupted operation

For the installation of the Unit, select a place which is stable, sheltered from heat radiation and direct sunshine. First, insert the power cord into the mains connector on the rear panel of control unit, then, plug it in the properly installed socket of electrical system.

Install the applicator and a suitable operating electrode.

The small hose(s) of the pneumatic foot-operated switch (switches) put properly into the coupling(s) on the rear panel (the connection is so hermetically fastened).

Install the cable of neutral electrode into the connector on the rear panel (move the blue collar clockwise slightly round till you feel, that the connector snaps down into the coupler plug /when disconnecting the neutral electrode always pull the grey collar back to you, and move slightly round contrariwise/) and place the neutral electrode directly on the patient body, without any separating tissue. If the use of BIPOLAR mode is needed install also the bipolar cable into the appropriate bipo connector on the rear panel and connect it with the selected Forceps.

Switch on the power-supply switch on the front panel - the indication by light signal. Select the required mode by the MONOPOLAR - BIPOLAR mode switch (picture 1), the switch position is indicated by the light signal. Select the operating output function, adjust the estimate intensity of the required output function by the output function selector (picture 1). The intensity is displayed on the digital display in the centre of the front panel (8, picture 1). Its adjustable steps are in the tables below:

<b>MONO CUT</b>				<b>BIPO COAGULATION</b>			
From	To	Steps		From	To	Steps	
1	- 20	1W		1	- 20	1W	
20	- 40	2W		20	- 40	2W	
40	- 200	10W		40	- 200	10W	
200	- 400	20W		200	- 260	20W	

Surgical treatment can be started by putting hand-operated or foot-operated switch into operation. The activation of the output function is indicated by the respective light signal (picture 1) and simultaneous uninterrupted acoustic signal.

The taking out of the neutral electrode at monopolar mode causes the activation of intermittent acoustic alarm and of red light signal (picture 1). In this case, however, this phenomenon doesn't indicate malfunction, but checks the correct function of the monitor circuit of neutral electrode.

No High frequency cables (including Applicator and Neutral Electrode cables) may be put on the Control Unit cabinet. In the case the Unit could switch off itself automatically.

Picture 1 - THE FRONT PANEL OF CONTROL UNIT:

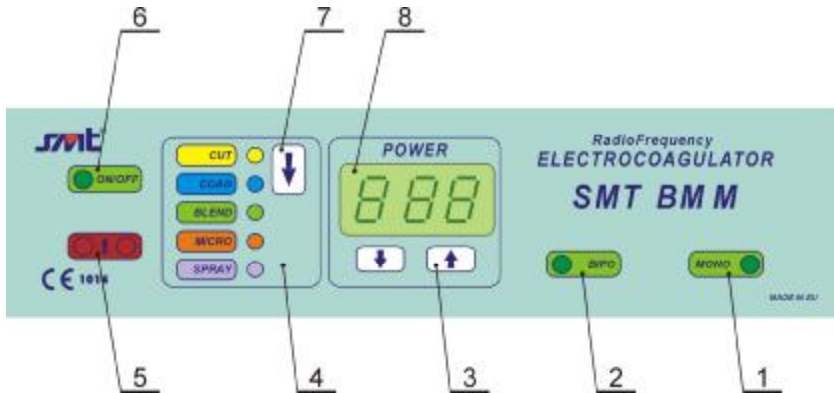

**Legend:**

1. monopolar mode reversing switch and signalization
2. bipolar mode reversing switch and signalization
3. digital regulator of intensity up and down
4. field of output selection
5. double red light signal-malfunction
6. main on/off switch and green light signal
7. selecting push button of chosen outputs CUT, COAG, BLEND, MICRO, SPRAY
8. digital display of chosen operating intensity

**CAUTION:** Any accessory with high frequency cables and wires **should not be put on nor led across** the Digital Operating Unit. This could cause a switching of the Unit!

If this happens the Unit can be normally switched on again.

**WARNING:**

The twin BIPOLAR Cable can only be used with BIPOLAR Socket.

**DANGER!**

Use of the BIPOLAR Cable with any MONOPOLAR Socked may cause burn of a patient!

Picture 2 - THE REAR PANEL OF CONTROL UNIT

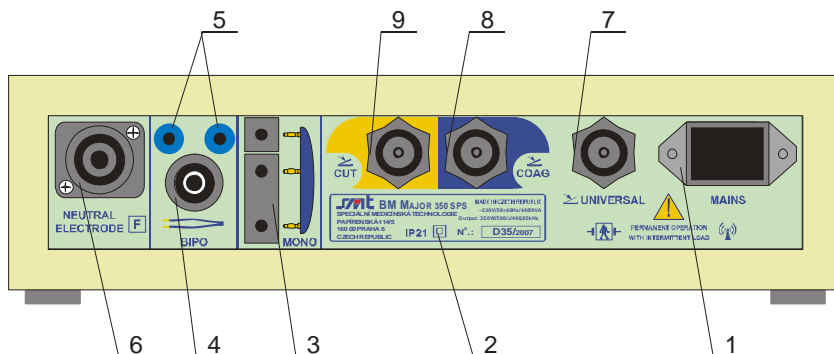

Legend:

- 1- power cable connector
  - 2- manufacturing label
  - 3- monopolar output connector
  - 4- bipolar output connector - for coaxial cable types
  - 5- bipolar output connector – for other common bipo cables with 4mm connectors
  - 6- neutral electrode connector
  - 7- universal pneumatic single foot switch coupler
  - 8- pneumatic double foot switch coupler COAG
  - 9- pneumatic double foot switch coupler CUT
- 7 and 8 with the models BM M S, BM M SPS only

## 5. MAINTENANCE

The Electrosurgical Set does not require any special maintenance, except usual cleanup of all parts. Have any repairing performed by the manufacturer or the chartered service.

### 5.1 Programs settings (only with the programmable Units “P”)

To set the desired programs press both buttons up and down (3 on the picture 1) of the digital regulator of intensity at the same time. The display will show the current program (P1-P12) for a period of 3 seconds. During this period it is possible to change these programs soever. After another 5 seconds it is possible to set and save all required working powers of any outputs for the future using. The memory automatically

saves any possible changes always after selecting a new program. The memory can save twelve different programs.

Desired mode you select by MONO or BIPO switch, with the choice indicated by signal light next to the inscriptions. The unit types BM M SP and SPS can select Special MODES (see chapter 8). Required type of coagulation for monopolar application is set by pressing "MONO" button for 3 seconds. During this time, the display unit shows the currently set type of coagulation ("Co.1, 2 or 3"). After 5 seconds the display returns to its original state. In a similar way - by pressing "BIPO" button for "Co.1, 2 or 3" bipolar coagulation. Operational COAG output you select and set by switch for functions, you need to press the big arrow.

Type	Standard mode	Special mode	Double foot switch
BM M	YES	NO	NO
BM M S	YES	NO	YES
BM M SP	YES	YES	NO
BM M SPS	YES	YES	YES

**Models:**

Model	Max. power [W]
150W-MINI	150
200W-MINOR	200
250W-MEDIA	260
300W-MEGAN	300
350W-MAJOR	360
400W-MAXIM	400

**Software:**

Standard	-	1 program
Program	P	12 programs

**5.2 Sterilization**

The sterilization of all parts which are in contact with patient body - electrode holders, patient neutral electrode, and also surgical electrode - can be done in autoclave, in plasma sterilizer or by subjecting to formaldehyde or ethylene-oxide. The sterilization of the operating electrodes (LOOP, BALL, scalpel, needle) can be also done by hot air, up to temperature 160°C. After each sterilization, it is necessary to do the preventative visual inspection of all connection cords of operating electrode holder and neutral electrode.

### **5.3 Cleaning**

The surface of the control unit case can be wiped with a damp gauze with addition of a usual detergent. However, do not allow washing solution to get inside.

The cleaning of electrodes can be analogous to the cleaning of the control unit case. In addition to this, before the sterilization, they must be cleaned also mechanically and sufficiently rinsed with running water.

### **5.4 Troubleshooting and Reparations**

If the electrode isn't effective enough, though the light signal lights up and the uninterrupted acoustic signal is on after pressing-down the hand or foot-operated switch, then recheck, whether the electrode is connected properly, and, whether the intensity of high-frequency current is adjusted correctly.

In case, when after switching on the Unit and pressing down the switch the electrode doesn't respond to it, and neither light nor acoustic signal function is on, even after checking carefully insertions of all connections, then the failure can be in the circuits of the control unit. In that case, you must contact a chartered service or directly the manufacturer.

In extreme case of overheating of the control unit the inbuilt automatic electronic system will switch the device off. This situation is signalized with both red lights (5 on the picture 1) and instead of the number of preselected working intensity there is only a line on the digital display 8 in the picture 1). Nevertheless no repair is necessary, the system will be automatically switched on - after some tens of seconds.

Never overlap the ventilation aperture on the side of the unit!

If there is some discrepancy in the function of the SMT BM M Electrosurgery system, try first of all to reset the Unit (and so the computer inside). Switch OFF and after 3 seconds switch ON the main switch on the left of the front panel of the Electronic Control Unit SMT BM M.

### **5.5 Preventative Inspections, Revisions**

The preventative inspections of the Electrosurgery Control Unit must be carried out minimum once a year, and of connection cords and



parts contacting patient body minimum once a half-year. The instrument and the contacting parts with cords must be checked visually after each sterilization (using above recommended technique).

The preventative revisions of the Operating Instruments and Accessories safety are obligatory once a year. This must be carried out by the manufacturer or at the chartered service.

## 5.6 Guarantee

The manufacturer guarantees that there will be no failure in the function of the Electrosurgery Unit for a period of 36 months from the date of installation. The manufacturer will repair the system free of charge during the guarantee period. The manufacturer shall not be held responsible for any damages to the system or improper performance of the system if the damage was caused by improper operation of the unit by the final user.

Manufacturer will make a **free of charge service** of the control unit **for another two years after the 3 year's guarantee** if the normal using conditions are fulfilled.

## 5.7 Instructions for the Realization of Guarantee Repair

Forward or transport personally the Unit, duly packed (preferably in the original covering), with the enclosed Indemnity Agreement and description of the failure, to the address of manufacturer, or to the address of the nearest relevant authorized service organization.

## 6. THE FULFILMENT OF LEGISLATIVE REQUIREMENTS

The conformity was reviewed with the product.

The manufacturer declares at its own responsibility exclusively that the product fulfils basic requirements stated in Annex 1 of Regulations of the Czech Government No. 336/2004 Coll. (93/42/EEC) in the relevant valid readings.

For the review were used these harmonised standards in a valid reading:

EN ISO 13485

EN 60601-1

EN 60601-1-2

EN 60601-2-2

The examination of the conformity was carried out in participation of the Authoritative person – Notified Body No. 1014.

The Manufacturer issued a Declaration of Conformity on this matter.

## 7. ELECTROSURGICAL UNIT AND SUPPLIED ACCESSORY



### 7.1 The basic accessory:

1. Electronic Control Unit with microprocessor
  2. Hand and/or Foot switch controlled Applicator
  3. Neutral electrode (silicone and/or 10dispersive disposable ones)
  4. Foot-operated safety pneumatic switch (4a - double pneumatic switch)
  5. Six operating electrodes
  6. Applicator Holder
  7. Power cord
- 
8. Operating Instructions (incl. Indemnity Agreement for 3 years and Final User Registration Card)
  9. Covering

### 7.2 The additional accessory:

1. Large selection of coagulation and resection electrodes and epilation needles (see Catalogue SMT, or the leaflets)
2. Applicator for epilation (with connection cord) 0,8 mm
3. Various forceps for bipolar application
4. Connection cord for forceps for bipolar application
5. Neutral dispersive electrode (disposable)
6. Connection cord (reusable, sterilizable) for disposable neutral electrode
7. Foot-operated safety double pneumatic switch CUT-COAG (only for the Units types "S" or "SPS")

8. Applicator Holder for ARGON incl. gas tubes
9. ARGON Unit + short connecting Cable with the ESU
10. Argon gas pressure Bottle with safety and regulating valves and tubes

## 8. APPENDIX

The SMT BM M Units are continuously developing.

The line marked S, SP and/or SPS is a new type range of the SMT BM M Units that are equipped - in addition - with double Pneumatic safety Footswitch (models "S" and "SPS") are determined, above all, for endoscopy use. And/or equipped with a new sophisticated special SP software (models "SP" and "SPS") that can be activated by Unit front panel switches if needed. These Units are determined for large operating rooms for an installation on ramp upon the operating place.

New features of the special (SP) software with the Units "SP", "SPS":  
If you have bought any SMT BM M type with the marking "SP" or "SPS" you can go in the special "SP" software by pushing both buttons **MONO and BIPO in the same time** for two seconds. The signal lights of the working outputs (CUT or COAG) twinkle. This is the difference between normal and special Mode "SP".

In the special Mode "SP" you can operate at a distance.

By pushing the double pedal (YELLOW-BLUE) you can select MONOPOLAR regime directly for a cutting (yellow pedal) or for a coagulation (blue pedal).

By pushing the single pedal (BLACK) you can activate BIPOLAR regime directly (coagulation only). The power has to be preselected before. (It rests preselected, even if the unit is switched off, untill the next selection.) You can return to the normal Mode by pushing both buttons for two seconds again.

## 9. MAXIMAL POWERS OF THE BM M UNITS

Type	Regime	Max Power						
		CUT	COAG 1	COAG 2	COAG 3	BLEND	MICRO	SPRAY
BM M 150 MINI	MONO	150 W	150 W	150 W	60 W	150 W	40 W	150 W
	BIPO	150 W	150 W	150 W	60 W	150 W	40 W	150 W
BM M 200 MINOR	MONO	200 W	200 W	200 W	60 W	200 W	40 W	200 W
	BIPO	200 W	200 W	200 W	60 W	200 W	40 W	200 W
BM M 250 MEDIA	MONO	260 W	260 W	200 W	60 W	260 W	40 W	260 W
	BIPO	260 W	260 W	200 W	60 W	260 W	40 W	260 W
BM M 300 MEGAN	MONO	300 W	300 W	200 W	60 W	300 W	40 W	300 W
	BIPO	300 W	260 W	200 W	60 W	300 W	40 W	300 W
BM M 350 MAJOR	MONO	360 W	300 W	200 W	60 W	360 W	40 W	360 W
	BIPO	340 W	260 W	200 W	60 W	320 W	40 W	340 W
BM M 400 MAXIM	MONO	400 W	300 W	200 W	60 W	380 W	40 W	400 W
	BIPO	340 W	260 W	200 W	60 W	320 W	40 W	340 W

# INDEMNITY AGREEMENT

**PRODUCT: HF/RF ELECTROSURGERY SET SMT BM M**

**TYPE: SMT BM M, SMT BM M S, SMT BM M SP, SMT BM M SPS**

**Or: SMT BM M P, SMT BM M P S, SMT BM M P SP, SMT BM M P SPS**

**MODEL:**

**BM M 150 MINI**

**BM M 250 MEDIA**

**BM M 350 MAJOR**

**BM M 200 MINOR**

**BM M 300 MEGAN**

**BM M 400 MAXIM**

**Serial number:**

**Date of sale:**

**Stamp and signature of expedition:**

**Guarantee Conditions:**

- a) At observing Operating Instructions the manufacturer guarantees that the product shall have characteristics assessed by the relevant technical conditions and standards for the duration of 36 months from the date of sale.
- b) In case of failure in function of the product, not caused by the end user or by an inevitable event within the guarantee period, the product will be repaired free of charge.
- c) The free of charge repair within the guarantee period will be done (after the presentation of the Indemnity Agreement) by an accredited service or by manufacturer.
- d) The guarantee period shall be extended for a term of the guarantee repair.
- e) Manufacturer guarantees also **two years service** of the control unit **free of charge after the 3 year's** guarantee period.
- f) The Indemnity Agreement is at the same time "The Certificate of the Quality and Completeness of the Product".



## RECORDS OF REPAIRS

Date of reception:

Description of malfunction:

Completion date:

Signature and stamp of the service

---

Date of reception:

Description of malfunction:

Completion date:

Signature and stamp of the service

---

Date of reception:

Description of malfunction:

Completion date:

Signature and stamp of the service

---

Date of reception:

Description of malfunction:

Completion date:

Signature and stamp of the service

---

Date of reception:

Description of malfunction:

Completion date:

Signature and stamp of the service

# FINAL USER REGISTRATION CARD

**PRODUCT: HF/RF ELECTROSURGERY SET SMT BM M**

**TYPE: SMT BM M, SMT BM M S, SMT BM M SP, SMT BM M SPS**

**Or: SMT BM M P, SMT BM M P S, SMT BM M P SP, SMT BM M P**

**SPS**

**MODEL:**

**BM M 150 MINI**

**BM M 250 MEDIA**

**BM M 350 MAJOR**

**BM M 200 MINOR**

**BM M 300 MEGAN**

**BM M 400 MAXIM**

Serial number:

Sales clerk:

User:

Name:

Organization:

Address:

Phone:

Fax:

Herewith I confirm that I have got acquainted with the Operating Instructions and with the Guarantee Conditions and I will observe them.

Date:

Signature:

Dear customers,

Will you tear this registration card out and forward it to the address: **Special Medical Technology Ltd., Papirenská 114/5, 160 00 Prague 6.**

The objective of this registration is, partly, to improve the quality of services our firm offers to its customers, and, partly, to observe strict requirements of International Standards our firm conforms and the user of medical technology must be acquainted with.

Thank You,

**Speciální Medicínská Technologie, s.r.o.**  
(Special Medical Technology, Ltd.)









**Specialni Medicinska Technologie, s.r.o.**  
/Special Medical Technology, Ltd./

Papírenská 114 / 5  
160 00 Praha 6, Czech Republic, EU  
Tel.: + 420 233 320 201  
Fax: + 420 224 318 011  
[obchod@smt-praha.com](mailto:obchod@smt-praha.com)  
[www.smt-praha.com](http://www.smt-praha.com)

**N 00123.04**

The last revision and issue of this Operating Instructions 5/7/2013.